



My Elf on the Shelf Scrapbook





This scrapbook is dedicated
to the _____ Family's
Scout Elf, _____, for
the _____ season.

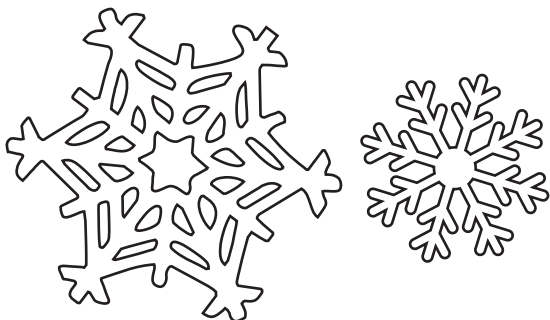

Elf-Ventures

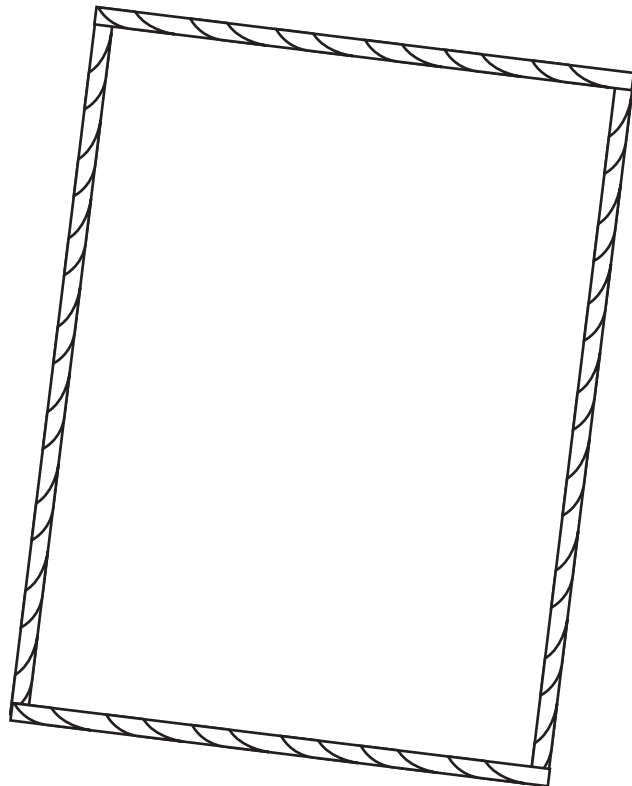
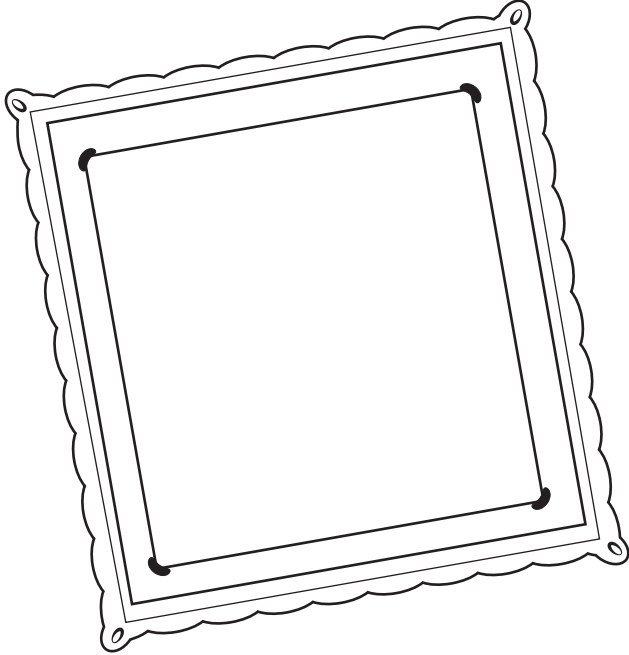

Elf-Ventures

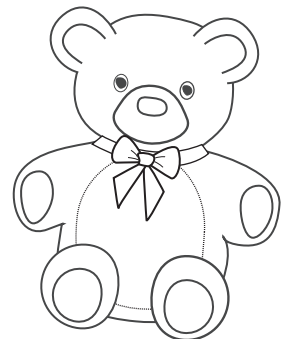
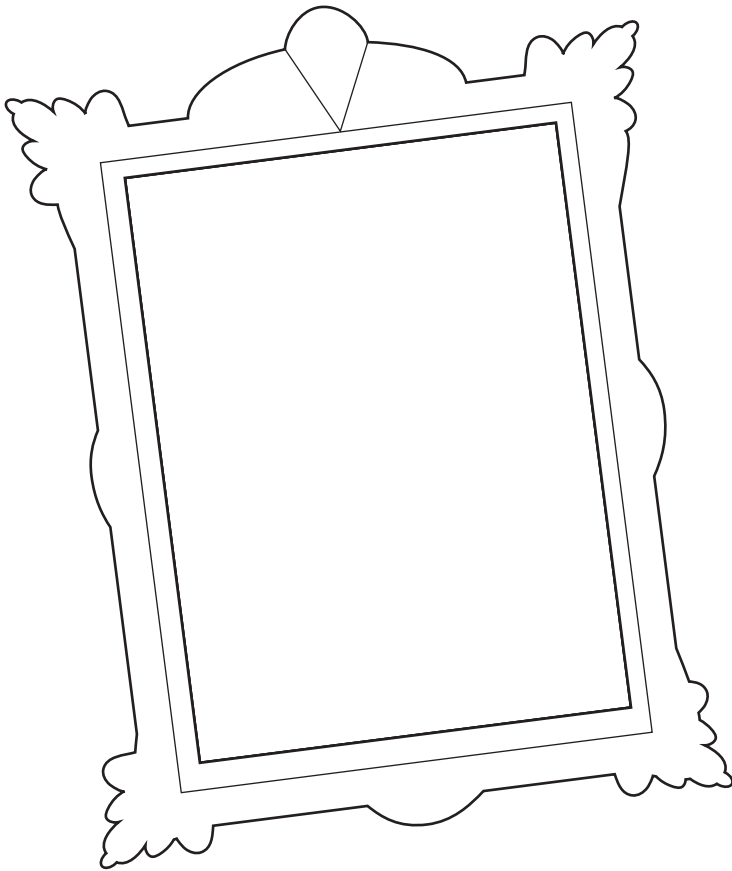
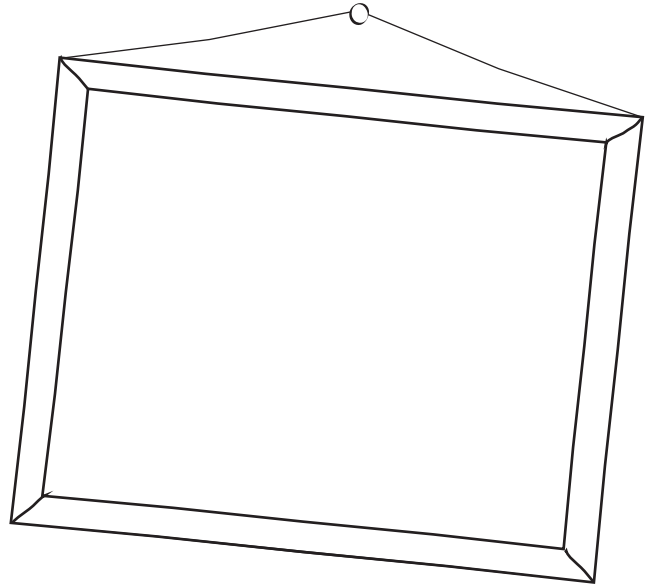
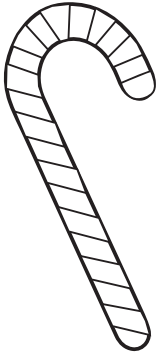

Elf-Ventures

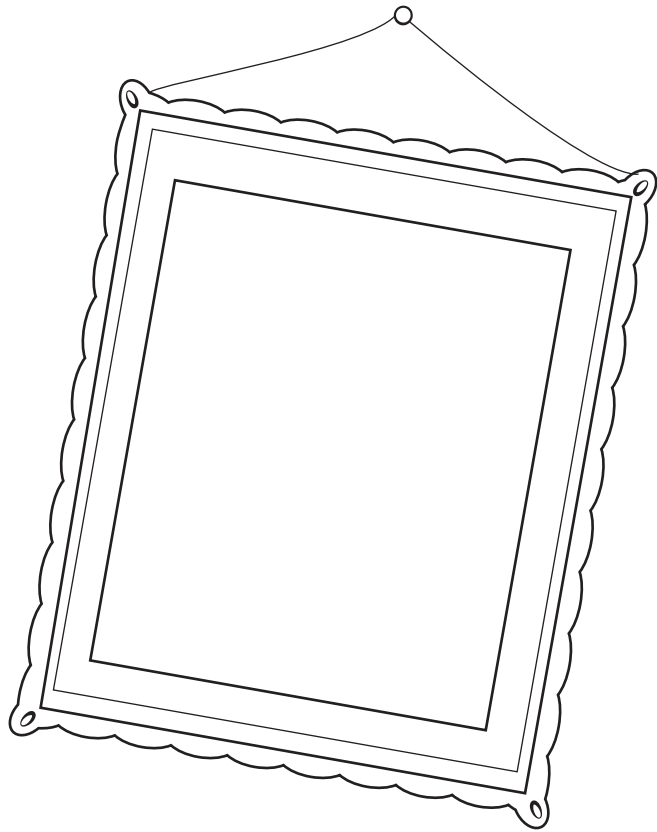
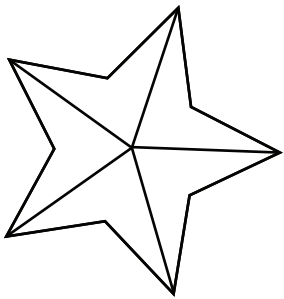
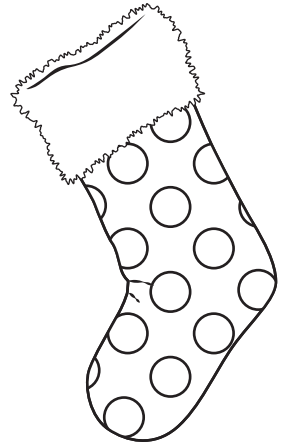
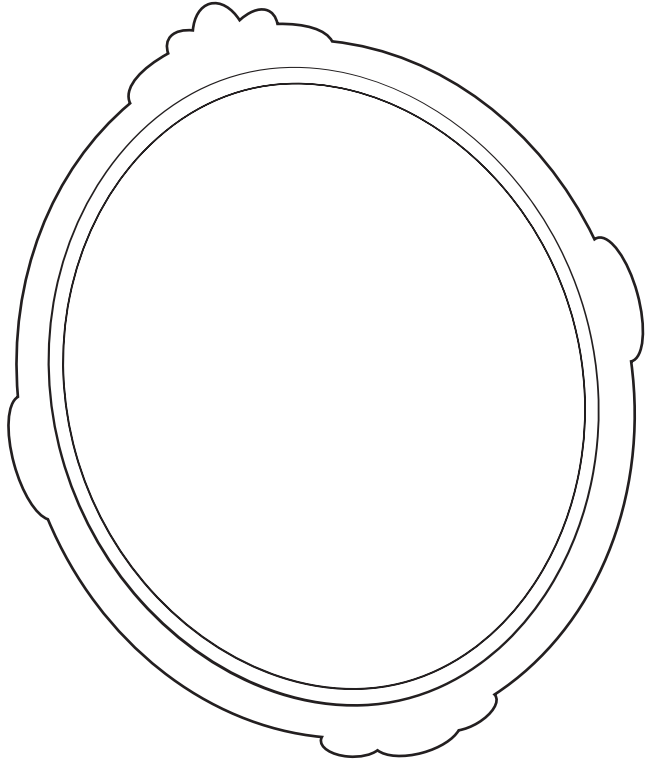

Elf-Ventures

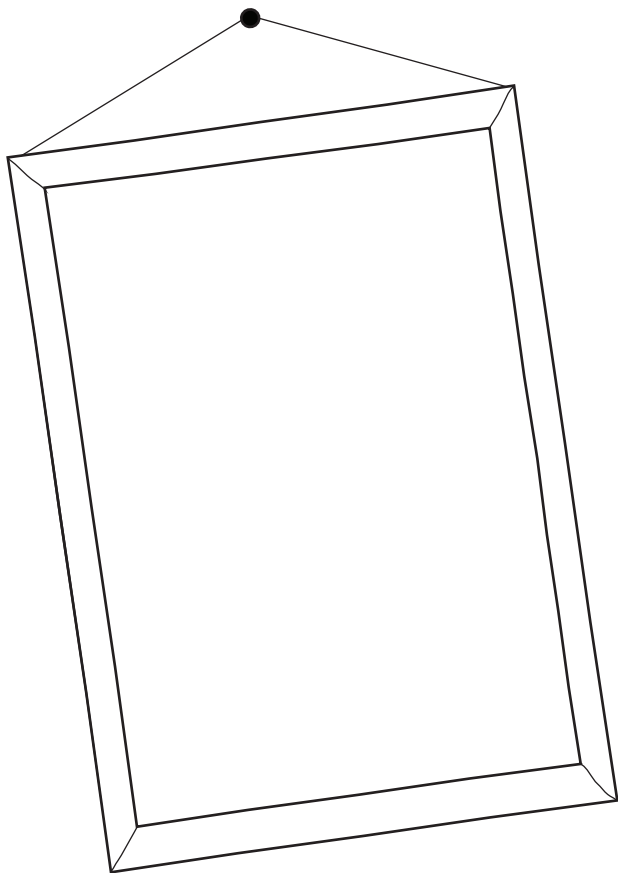
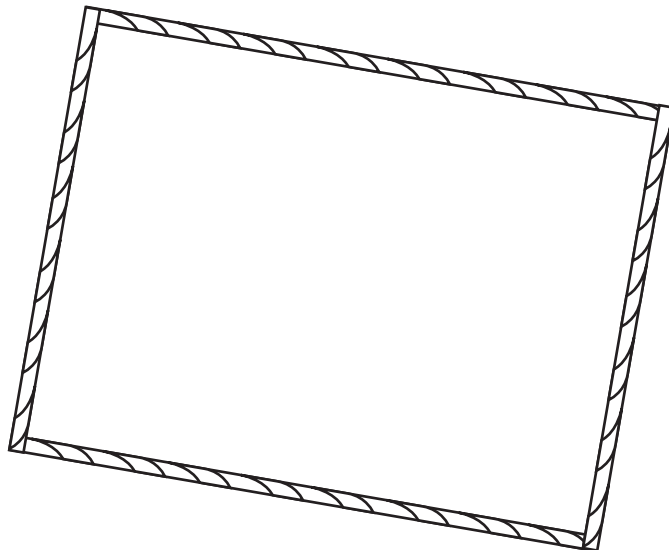
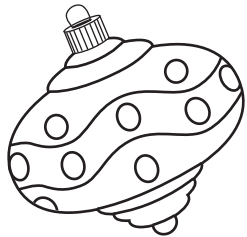

To Tell My Elf:

Jot down plans and wishes for the year, so you can tell your elf about your adventures when they return.

To Tell My Elf :

**Jot down plans and wishes for the year, so you can tell your elf
about your adventures when they return.**

Elf Visit Wishlist

Keep a list of holidays and special days you want your elf to come for a visit.

1. _____

2. _____

3. _____

4. _____

Official Scout Elf Special Visit Request Form

I would like _____

to return for a special

visit on _____

because _____

_____ .



Official Scout Elf Special Visit Request Form

I would like _____

to return for a special

visit on _____

because _____

_____ ●

